

Technical Information

Memosens CCS50D

Digital sensor with Memosens technology for determining chlorine dioxide

Memosens CCS50D offers high-precision measurement with long-term stability to guarantee optimum process monitoring



Application

Memosens CCS50D is a chlorine dioxide sensor for skid manufacturers and end customers. It measures reliably in:

- Drinking water: ensures adequate disinfection
- Cooling water systems: prevents the formation of pathogens
- Water used to wash pre-packaged vegetables and salads to ensure high food quality
- Beverage systems: ensures the absence of chlorine dioxide

Your benefits

- The right choice of sensor for every application: from trace measurements to chlorine dioxide concentrations of 200 mg/l.
- Fast response time ensures accurate process monitoring and enables a prompt response to process changes, as well as efficient process control.
- Increased process safety: Accurate measurements with longterm stability ensure consistent process monitoring and the lowest possible disinfectant concentrations.
- Flexible installation: The sensor can be installed in flow assemblies CCA151 and CCA250 or in an immersion assembly. From flow rates of 5 l/h (CCA151), 30 l/h (CCA250) or 15 cm/s (immersion operation), measurement is virtually independent of flow.
- Higher system availability thanks to rapid sensor replacement: calibrate your sensor in the lab and integrate it into the process using plug & play.
- It can be easily combined with other relevant liquid analysis parameters by connecting to the Liquiline multi-parameter transmitter.

Other advantages provided by Memosens technology

- Maximum process safety
- Data security thanks to digital data transmission
- Very easy to use as sensor data are saved in the sensor
- Predictive maintenance can be performed by recording sensor load data in the sensor

Function and system design

Measuring principle

Chlorine dioxide levels are determined in accordance with the amperometric measuring principle.

The chlorine dioxide (ClO_2) in the medium diffuses through the sensor membrane and is reduced to chloride ions (Cl^-) at the gold working electrode. At the silver counter electrode, silver is oxidized to silver chloride. Electron donation at the gold working electrode and electron acceptance at the silver counter electrode cause a current to flow which is proportional to the concentration of chlorine dioxide in the medium. This process does not depend on the pH value over a wide range.

The transmitter uses the current signal to calculate the measured variable for concentration in mg/l (ppm).

Mode of operation

The sensor consists of:

- Membrane cap (measuring chamber with membrane)
- Sensor shaft with counter-electrode with large surface area and a working electrode embedded in plastic

The electrodes are in an electrolyte which is separated from the medium by a membrane. The membrane prevents the electrolyte from leaking and protects against contaminant penetration.

The measuring system is calibrated by means of a colorimetric comparison measurement in accordance with the DPD method for chlorine dioxide. The calibration value determined is entered in the transmitter.

Cross-sensitivities ¹⁾

Free chlorine, ozone, free bromine

There were no cross-sensitivities for: H_2O_2 , peracetic acid

Measuring system

A complete measuring system comprises:

- Disinfection sensor CCS50D (membrane-covered, $\varnothing 25$ mm) with corresponding installation adapter
- Flowfit CCA151 flow assembly
- Measuring cable CYK10, CYK20
- Transmitter, e.g. Liquiline CM44x with firmware version 01.06.08 or higher or CM44xR with firmware version 01.06.08 or higher
- Optional: extension cable CYK11
- Optional: proximity switch
- Optional: CPS31
- Optional: Flowfit CCA250 flow assembly (a pH/ORP sensor can additionally be installed here)
- Optional: immersion assembly Flexdip CYA112

1) The listed substances have been tested individually and with different concentrations. A reaction to mixtures was not investigated.

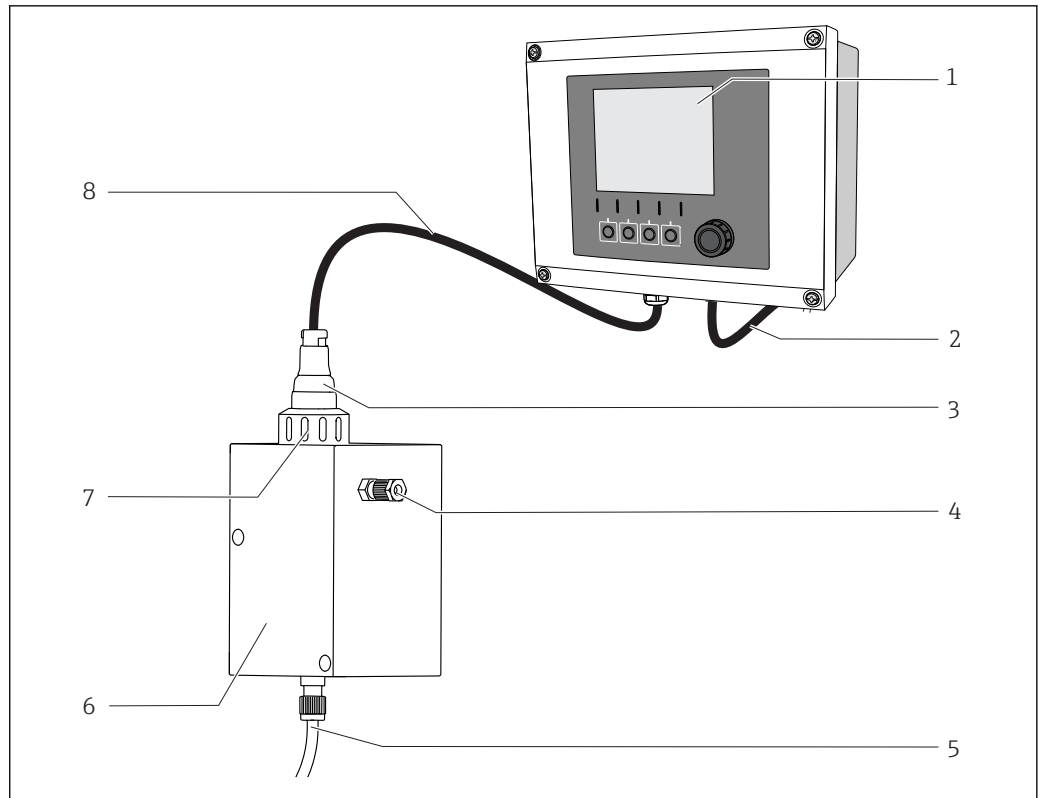

A0034241

1 Example of a measuring system

- 1 Liquiline CM44x transmitter
- 2 Power cable for transmitter
- 3 Disinfection sensor CCS50D (membrane-covered, Ø25 mm)
- 4 Outlet from Flowfit CCA151 flow assembly
- 5 Inlet to Flowfit CCA151 flow assembly
- 6 Flowfit CCA151 flow assembly
- 7 Union nut for installing a disinfection sensor in the Flowfit CCA151 flow assembly
- 8 Measuring cable CYK10

Dependability

Reliability

Memosens

Memosens makes your measuring point safer and more reliable:

- Non-contact, digital signal transmission enables optimum galvanic isolation
- Dust- and waterproof (IP 68)
- Sensor can be calibrated in a lab, thus increasing the availability of the measuring point in the process
- Predictive maintenance thanks to recording of sensor data, e.g.:
 - Total hours of operation
 - Hours of operation with very high or very low measured values
 - Hours of operation at high temperatures
 - Calibration history

Maintainability

Easy handling

Sensors with Memosens-technology have integrated electronics that store calibration data and other information (e. g. total hours of operation or operating hours under extreme measuring conditions). Once the sensor has been connected, the sensor data are transferred automatically to the transmitter

and used to calculate the current measured value. As the calibration data are stored in the sensor, the sensor can be calibrated and adjusted independently of the measuring point. The result:

- Easy calibration in the measuring lab under optimum external conditions increases the quality of the calibration.
- Pre-calibrated sensors can be replaced quickly and easily, resulting in a dramatic increase in the availability of the measuring point.
- Thanks to the availability of the sensor data, maintenance intervals can be accurately defined and predictive maintenance is possible.
- The sensor history can be documented on external data carriers and in evaluation programs.
- Thus, the current application of the sensors can be made to depend on their previous history.

Safety

Data security thanks to digital data transmission

Memosens technology digitizes the measured values in the sensor and transmits the data to the transmitter via a non-contact connection that is free from potential interference. The result:

- Automatic error message if sensor fails or connection between sensor and transmitter is interrupted
- Immediate error detection increases measuring point availability

Input

Measured values	Chlorine dioxide (ClO ₂) Temperature	[mg/l, µg/l, ppm, ppb] [°C, °F]
Measuring ranges	CCS50D-**11AD CCS50D-**11BF CCS50D-**11CJ	0 to 5 mg/l (ppm) ClO ₂ 0 to 20 mg/l (ppm) ClO ₂ 0 to 200 mg/l (ppm) ClO ₂
Signal current	CCS50D-**11AD CCS50D-**11BF CCS50D-**11CJ	135 to 250 nA per 1 mg/l (ppm) ClO ₂ 35 to 65 nA per 1 mg/l (ppm) ClO ₂ 4 to 8 nA per 1 mg/l (ppm) ClO ₂

Power supply

Electrical connection

The electrical connection to the transmitter is established using measuring cable CYK10 or CYK20.

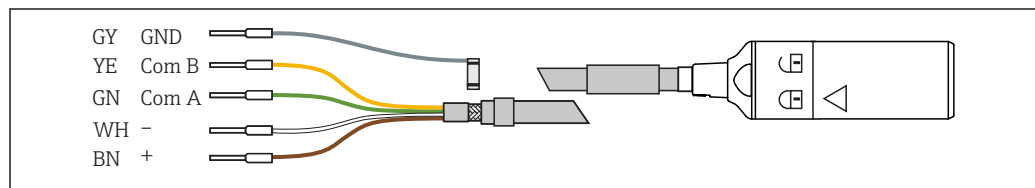

2 Measuring cable CYK10/CYK20

- ▶ To extend the cable, use measuring cable CYK11. The maximum cable length is 100 m (328 ft).

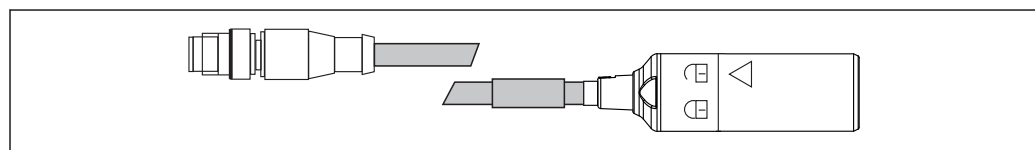

3 Electrical connection, M12 plug

Performance characteristics

Reference operating conditions	Temperature	20 °C (68 °F)	
	pH value	pH 6 to 7	
	Flow	40 to 60 cm/s	
	ClO ₂ -free base medium	Deionized water	
Response time	T ₉₀ < 15 s (after completing polarization)		
Measured value resolution of sensor	CCS50D-**11AD	0.03 µg/l (ppb) ClO ₂	
	CCS50D-**11BF	0.13 µg/l (ppb) ClO ₂	
	CCS50D-**11CJ	1.1 µg/l (ppb) ClO ₂	
Measured error ²⁾	±2 % or ±5 µg/l (ppb) of value measured (depending on which value is higher)		
		LOD (limit of detection)	LOQ (limit of quantification)
	CCS50D-**11AD	0.0007 mg/l (ppm)	0.002 mg/l (ppm)
	CCS50D-**11BF	0.0013 mg/l (ppm)	0.004 mg/l (ppm)
CCS50D-**11CJ	0.0083 mg/l (ppm)	0.025 mg/l (ppm)	
Repeatability	CCS50D-**11AD	0.002 mg/l (ppm)	
	CCS50D-**11BF	0.007 mg/l (ppm)	
	CCS50D-**11CJ	0.025 mg/l (ppm)	
Nominal slope	CCS50D-**11AD	195 nA per 1 mg/l (ppm) ClO ₂	
	CCS50D-**11BF	50 nA per 1 mg/l (ppm) ClO ₂	
	CCS50D-**11CJ	6 nA per 1 mg/l (ppm) ClO ₂	
Long-term drift	< 1 % per month (mean value, determined while operating at varying concentrations and under reference conditions)		
Polarization time	Initial commissioning	60 min	
	Recommissioning	30 min	
Operating time of the electrolyte	at maximum concentration and 55 °C	60 days	
	at 50 % of measuring range and 20 °C	1 year	
	at 10 % of measuring range and 20 °C	2 years	

2) Based on ISO 15839. The measured error includes all the uncertainties of the sensor and transmitter (measuring chain). It does not contain all the uncertainties caused by the reference material and adjustments that may have been performed.

Installation

Orientation

Do not install upside-down!

- ▶ Install the sensor in an assembly, support or appropriate process connection at an angle of at least 15 ° to the horizontal.
- ▶ Other angles of inclination are not permitted.
- ▶ Follow the instructions for installing the sensor in the Operating Instructions of the assembly used.

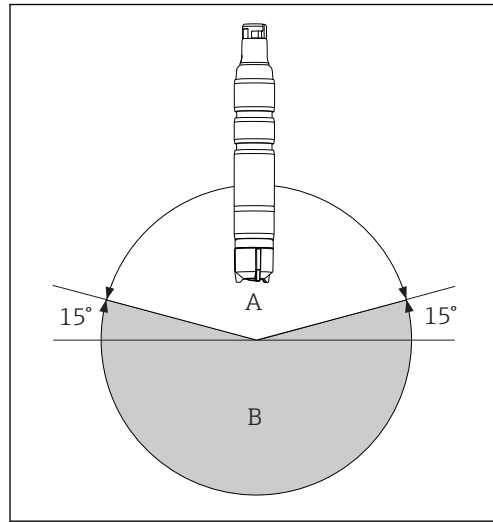

A Permitted orientation
B Incorrect orientation

Immersion depth

50 mm (1.97 in)

Installation instructions

Installation in Flowfit CCA151 flow assembly

The disinfection sensor (membrane-covered, $\varnothing 25$ mm) is designed for installation in the Flowfit CCA151 flow assembly.

Please note the following during installation:

- ▶ The flow rate must be at least 5 l/h (1.3 gal/h).
- ▶ If the medium is returned to an overflow basin, pipe or similar, the resulting counterpressure on the sensor must not exceed 1 bar (14.5 psi) and must remain constant.
- ▶ Avoid negative pressure at the sensor, e.g. due to medium being returned to the suction side of a pump.
- ▶ To avoid buildup, heavily contaminated water should also be filtered.

Preparing assembly

1. The assembly is supplied to the customer with a union nut screwed onto the assembly: unscrew union nut from assembly.

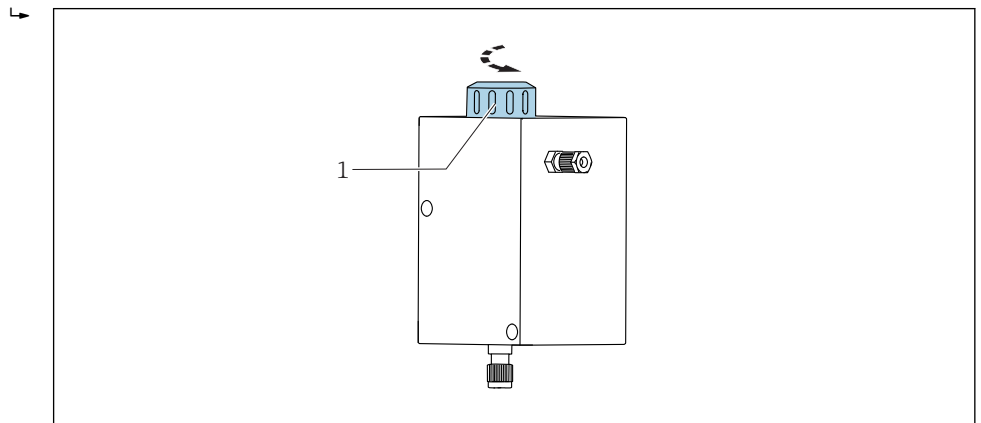

4 Flowfit CCA151 flow assembly

1 Union nut

2. The assembly is supplied to the customer with a dummy plug inserted in the assembly: remove dummy plug from assembly.

Equip sensor with adapter

The required adapter (clamping ring, thrust collar and O-ring) can be ordered as a mounted sensor accessory or as a separate accessory → 13.

1. First slide the clamping ring, then the thrust collar, and then the O-ring from the membrane cap towards the sensor head and into the lower groove.

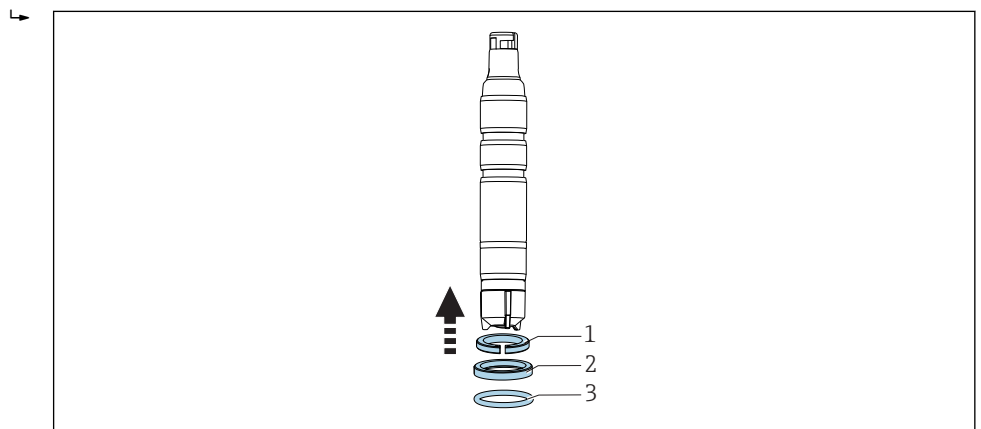

5 Slide clamping ring (1), thrust collar (2) and O-ring (3) upwards from the membrane cap to the sensor shaft and into the lower groove.

Installing sensor in assembly

2. Slide sensor with adapter for Flowfit CCA151 into the opening in the assembly.

3. Screw union nut onto assembly on block.

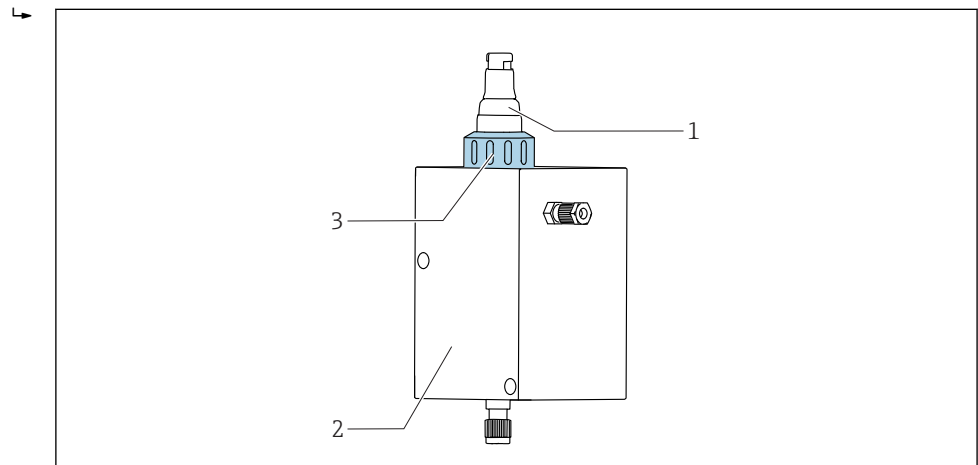

A0034261

 6 Flowfit CCA151 flow assembly

1 Disinfection sensor

2 Flowfit CCA151 flow assembly

3 Union nut for securing a disinfection sensor

Installation in Flowfit CCA250 flow assembly

The sensor can be installed in the Flowfit CCA250 flow assembly. This allows a pH and an ORP sensor to also be installed, in addition to the chlorine or chlorine dioxide sensor. A needle valve controls the flow in the range of 30 to 120 l/h (7.9 to 31.7 gal/h).

Please note the following during installation:

- ▶ The flow rate must be at least 30 to 120 l/h (7.9 to 31.7 gal/h). If the flow drops below this value or stops completely, this can be detected by an inductive proximity switch and used to trigger an alarm with locking of the dosage pumps.
- ▶ If the medium is returned to an overflow basin, pipe or similar, the resulting counterpressure on the sensor must not exceed 1 bar (14.5 psi) and must remain constant.
- ▶ Negative pressure at the sensor, e.g. due to medium being returned to the suction side of a pump, must be avoided.

Equip sensor with adapter

The required adapter can be ordered as a mounted sensor accessory or as a separate accessory. →  13

1. Slide adapter for Flowfit CCA250 from the sensor head up to the stop on the sensor.

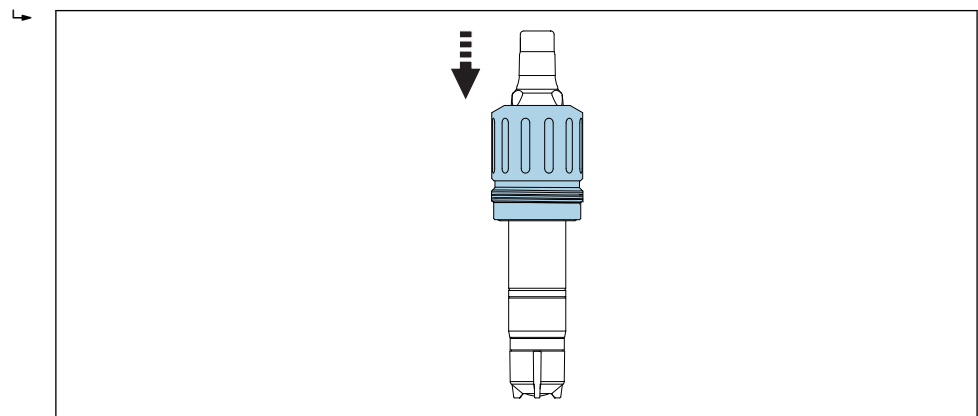

A0034245

 7 Slide on adapter for Flowfit CCA250.

2. Lock the adapter in place using the two studs provided.



For detailed information on "Installing sensor in Flowfit CCA250 assembly", see Operating Instructions for assembly

Installation in other flow assemblies

When using other flow assemblies, please ensure the following:

- ▶ A flow velocity of at least 15 cm/s (0.49 ft/s) must always be ensured at the membrane.
- ▶ The flow direction is upwards. Transported air bubbles must be removed so that they do not collect in front of the membrane.
- ▶ The flow must be directed to the membrane.

 Pay attention to the additional installation instructions in the Operating Instructions for the assembly.

Installation in Flexdip CYA112 immersion assembly

Alternatively, the sensor can be installed in an immersion assembly with G1 threaded connection, e. g.

Equip sensor with adapter

The required adapter can be ordered as a mounted sensor accessory or as a separate accessory. →  13

1. Slide adapter for Flexdip CYA112 from the sensor head up to the stop on the sensor.

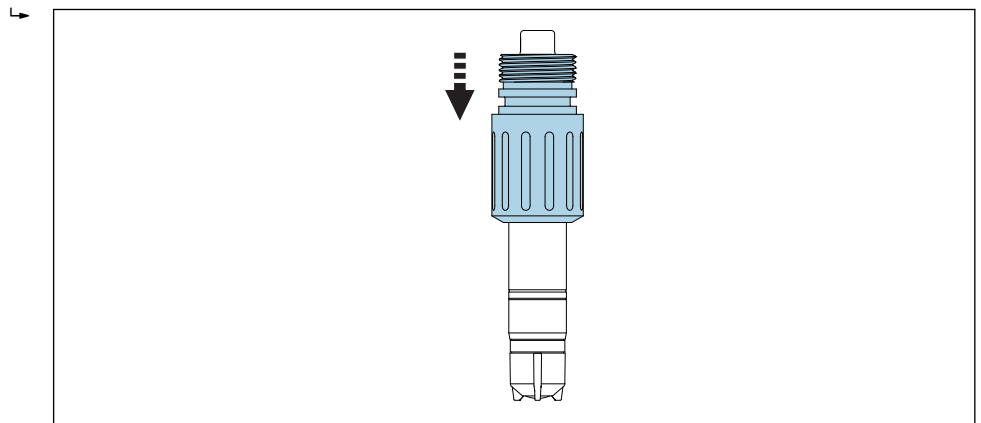

 8 Slide on adapter for Flexdip CYA112.

2. Lock the adapter in place using the two studs provided.

 For detailed information on "Installing sensor in Flexdip CYA112 assembly", see Operating Instructions for assembly

Environment

Ambient temperature -20 to 60 °C (-4 to 140 °F)

Storage temperature	Longterm storage		Storage up to max 48 h
	With electrolyte	0 to 35 °C (32 to 95 °F) (non-freezing)	
Without electrolyte	-20 to 60 °C (-4 to 140 °F)		

Degree of protection IP68 (1.8 m (5.91 ft) water column over 7 days at 20 °C (68 °F))

Process

Process temperature 0 to 55 °C (32 to 130 °F), non-freezing

Process pressure The inlet pressure depends on the specific fitting and installation.

The measurement can take place with a free outlet.

The sensor can be operated at process pressures up to 1 bar (14.5 psi) (2 bar abs. (29 psi abs.)).

- In terms of sensor condition and performance, it is essential that the flow velocity limits specified in the following table be observed.

	Flow velocity [cm/s]	Volume flow [l/h]		
		Flowfit CCA250	Flowfit CCA151	Flexdip CYA112
Minimum	15	30	5	The sensor is suspended freely in the medium; pay attention to the minimum flow velocity of 15 cm/s during installation.
Maximum	80	145	20	

pH range

Stability range of chlorine dioxide (ClO₂) pH 2 to 10¹⁾

Calibration pH 4 to 8

Measurement pH 4 to 9

From pH values > 9, ClO₂ is unstable and decomposes.

- 1) Up to pH 3.5 and in the presence of chloride ions (Cl⁻), free chlorine is produced and included in the measurement

Flow

At least 5 l/h (1.3 gal/h), in the Flowfit CCA151 flow assembly

At least 30 l/h (7.9 gal/h), in the Flowfit CCA250 flow assembly

Minimum flow

At least 15 cm/s (0.5 ft/s) , e.g. with Flexdip CYA112 immersion assembly

Mechanical construction

Dimensions

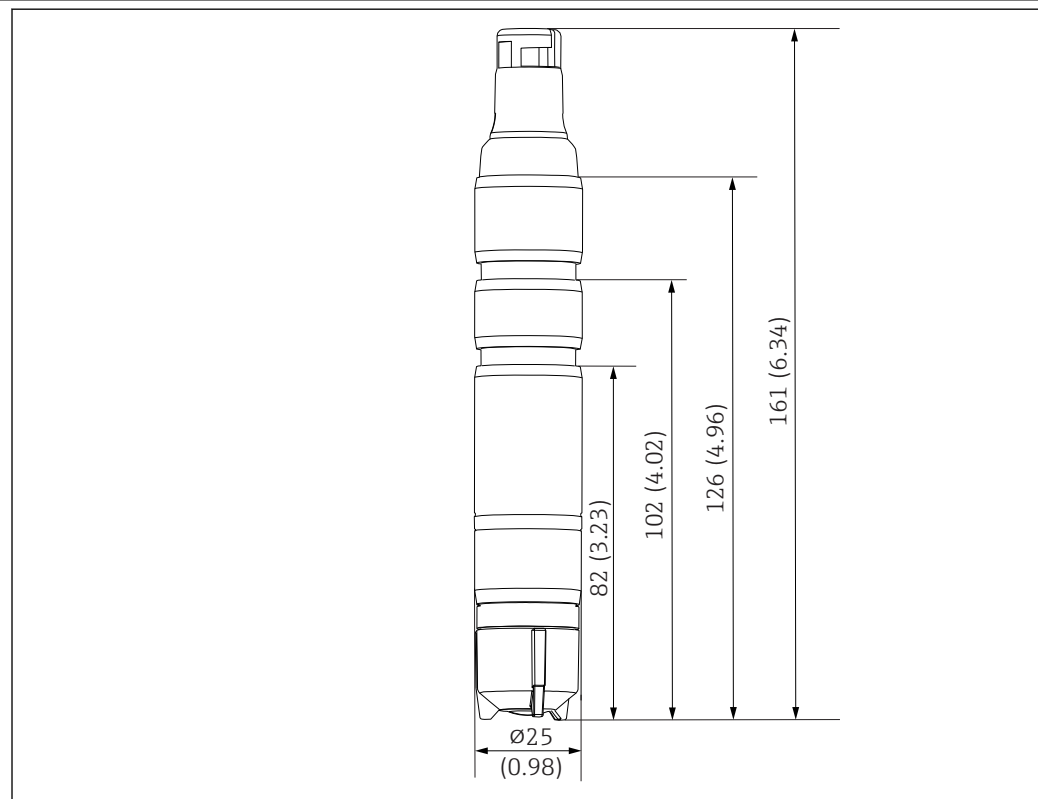

9 Dimensions in mm (in)

A0034238

Weight	Sensor with membrane cap and electrolyte (without protection cap and without adapter) Approx. 95 g (3.35 oz)	
Materials	Sensor shaft	PVC
	Membrane	PVDF
	Membrane cap	PVDF
	Protection cap	<ul style="list-style-type: none"> ■ Vessel: PC Makrolon (polycarbonate) ■ Seal: Kraiburg TPE TM5MED ■ Cover: PC Makrolon (polycarbonate)
	Sealing ring	FKM
Cable specification	max. 100 m (330 ft), incl. Cable extension	

Certificates and approvals

CE mark	<p>Declaration of conformity</p> <p>The product meets the requirements of the harmonized European standards. As such, it complies with the legal specifications of the EU directives. The manufacturer confirms successful testing of the product by affixing to it the CE mark.</p>
EAC	<p>The product has been certified according to guidelines TP TC 004/2011 and TP TC 020/2011 which apply in the European Economic Area (EEA). The EAC conformity mark is affixed to the product.</p>
Ex approvals³⁾	<p>cCSAus NI Cl. I, Div. 2</p> <p>This product complies with the requirements defined in:</p> <ul style="list-style-type: none"> ■ UL 61010-1 ■ ANSI/ISA 12.12.01 ■ FM 3600 ■ FM 3611 ■ CSA C22.2 NO. 61010-1-12 ■ CSA C22.2 NO. 213-16 ■ Control drawing: 401204

Ordering information

Product page	www.endress.com/ccs50d
Product Configurator	<p>On the product page there is a Configure button to the right of the product image.</p> <ol style="list-style-type: none"> 1. Click this button. <ul style="list-style-type: none"> ↳ The Configurator opens in a separate window. 2. Select all the options to configure the device in line with your requirements. <ul style="list-style-type: none"> ↳ In this way, you receive a valid and complete order code for the device. 3. Export the order code as a PDF or Excel file. To do so, click the appropriate button on the right above the selection window. <p> For many products you also have the option of downloading CAD or 2D drawings of the selected product version. Click the CAD tab for this and select the desired file type using picklists.</p>

3) Only if connected to CM44x(R)-CD*

Scope of delivery

The delivery comprises:

- Disinfection sensor (membrane-covered, Ø25 mm) with protection cap (ready for use)
- Bottle with electrolyte (50 ml (1.69 fl.oz))
- Replacement membrane cap in protection cap
- Operating Instructions
- Manufacturer inspection certificate

Accessories

The following are the most important accessories available at the time this documentation was issued.

- ▶ For accessories not listed here, please contact your Service or Sales Center.

Maintenance kit CCV05

Order according to product structure

- 2 x membrane caps and 1 x electrolyte 50 ml (1.69 fl.oz)
- 1 x electrolyte 50 ml (1.69 fl.oz)
- 2 x sealing set

Device-specific accessories

Memosens data cable CYK10

- For digital sensors with Memosens technology
- Product Configurator on the product page: www.endress.com/cyk10



Technical Information TI00118C

Memosens data cable CYK11

- Extension cable for digital sensors with Memosens protocol
- Product Configurator on the product page: www.endress.com/cyk11



Technical Information TI00118C

Memosens laboratory cable CYK20

- For digital sensors with Memosens technology
- Product Configurator on the product page: www.endress.com/cyk20

Flowfit CCA151

- Flow assembly for chlorine dioxide sensors
- Product Configurator on the product page: www.endress.com/cca151



Technical Information TI01357C

Flowfit CCA250

- Flow assembly for chlorine and pH/ORP sensors
- Product Configurator on the product page: www.endress.com/cca250



Technical Information TI00062C

Flexdip CYA112

- Immersion assembly for water and wastewater
- Modular assembly system for sensors in open basins, channels and tanks
- Material: PVC or stainless steel
- Product Configurator on the product page: www.endress.com/cya112



Technical Information TI00432C

Photometer PF-3

- Compact hand-held photometer for determining the free available chlorine and total chlorine concentration
- Color-coded reagent bottles with clear dosing instructions
- Order No.: 71257946

Kit adapter CCS5xD for CCA151

- Clamping ring
- Thrust collar
- O-ring
- Order No. 71372027

Adapter kit CCS5x(D) for CCA250

- Adapter incl. O-rings
- 2 studs for locking in place
- Order No. 71372025

Adapter kit CCS5x(D) for CYA112

- Adapter incl. O-rings
- 2 studs for locking in place
- Order No. 71372026

COY8

Zero-point gel for oxygen and disinfection sensors

- Oxygen-free and chlorine-free gel for the verification, zero point calibration and adjustment of oxygen and disinfection measuring points
- Product Configurator on the product page: www.endress.com/coy8



Technical Information TI01244C

www.addresses.endress.com
