

FLUKE®

Model 2042

Cable Locator

Users Manual

PN 2438531

May 2005 (English)

© 2005 Fluke Corporation. All rights reserved. Printed in China.

Fluke 2042
LIMITED WARRANTY AND LIMITATION OF LIABILITY

LIMITED WARRANTY AND LIMITATION OF LIABILITY

Each Fluke product is warranted to be free from defects in material and workmanship under normal use and service. The warranty period is one year and begins on the date of shipment. Parts, product repairs, and services are warranted for 90 days. This warranty extends only to the original buyer or end-user customer of a Fluke authorized reseller, and does not apply to fuses, disposable batteries, or to any product which, in Fluke's opinion, has been misused, altered, neglected, contaminated, or damaged by accident or abnormal conditions of operation or handling. Fluke warrants that software will operate substantially in accordance with its functional specifications for 90 days and that it has been properly recorded on non-defective media. Fluke does not warrant that software will be error free or operate without interruption.

Fluke authorized resellers shall extend this warranty on new and unused products to end-user customers only but have no authority to extend a greater or different warranty on behalf of Fluke. Warranty support is available only if product is purchased through a Fluke authorized sales outlet or Buyer has paid the applicable international price. Fluke reserves the right to invoice Buyer for importation costs of repair/replacement parts when product purchased in one country is submitted for repair in another country.

Fluke's warranty obligation is limited, at Fluke's option, to refund of the purchase price, free of charge repair, or replacement of a defective product which is returned to a Fluke authorized service center within the warranty period.

To obtain warranty service, contact your nearest Fluke authorized service center to obtain return authorization information, then send the product to that service center, with a description of the difficulty, postage and insurance prepaid (FOB Destination). Fluke assumes no risk for damage in transit. Following warranty repair, the product will be returned to Buyer, transportation prepaid (FOB Destination). If Fluke determines that failure was caused by neglect, misuse, contamination, alteration, accident, or abnormal condition of operation or handling, including overvoltage failures caused by use outside the product's specified rating, or normal wear and tear of mechanical components, Fluke will provide an estimate of repair costs and obtain authorization before commencing the work. Following repair, the product will be returned to the Buyer transportation prepaid and the Buyer will be billed for the repair and return transportation charges (FOB Shipping Point).

THIS WARRANTY IS BUYER'S SOLE AND EXCLUSIVE REMEDY AND IS IN LIEU OF ALL OTHER WARRANTIES, EXPRESS OR IMPLIED, INCLUDING BUT NOT LIMITED TO ANY IMPLIED WARRANTY OF MERCHANTABILITY OR FITNESS FOR A PARTICULAR PURPOSE. FLUKE SHALL NOT BE LIABLE FOR ANY SPECIAL, INDIRECT, INCIDENTAL, OR CONSEQUENTIAL DAMAGES OR LOSSES, INCLUDING LOSS OF DATA, ARISING FROM ANY CAUSE OR THEORY.

Since some countries or states do not allow limitation of the term of an implied warranty, or exclusion or limitation of incidental or consequential damages, the limitations and exclusions of this warranty may not apply to every buyer. If any provision of this Warranty is held invalid or unenforceable by a court or other decision-maker of competent jurisdiction, such holding will not affect the validity or enforceability of any other provision.

| | |
|-------------------|---------------------|
| Fluke Corporation | Fluke Europe B.V. |
| P.O. Box 9090 | P.O. Box 1186 |
| Everett WA | 5602 B.D. Eindhoven |
| 98206-9090 | Netherlands |

| | Page |
|---|------|
| General Information / Introduction /Scope of Supply | 4 |
| Product Description | 4 |
| Scope of supply | 5 |
| Transport and Storage | 5 |
| Safety Measures..... | 5 |
| Appropriate Usage | 7 |
| Operation Elements and Connections | 7 |
| Carrying out measurement..... | 11 |
| Theoretical functional principle..... | 12 |
| Locator in complete circuits | 12 |
| Important Application | 12 |
| In open circuits (one pole application) | 14 |
| In complete circuits (double pole application) | 14 |
| Locating and tracing of lines, sockets, switches and junctions in house installations circuits..... | 15 |
| Locating of line interruptions | 16 |
| Precise locating of line interruptions using two transmitters | 16 |
| Error detection for a electrical floor heating (one-pole application) | 18 |
| Locating of bottlenecks (obstructions) in installation pipes | 18 |
| Locating Fuses (dual-pole application)..... | 19 |
| Locating of short-circuits in conductors (double-pole applicaion | 19 |
| Tracing installed water and heating pipes (one-pole application)..... | 20 |
| Detecting the direction of water and heating pipes already installed | 21 |
| Locating a complete house wiring (one-pole application) | 21 |
| Following lines with higher location depth (dual-pole application) | 22 |
| Tracing Conductors Within the soil (single-pole application) | 22 |
| The reach will be improved when seeking the tension..... | 23 |
| Sorting or determination of conductors already installed | 24 |
| Mains Voltage Detection Locating Line Interruptions | 24 |
| Setting the Codes..... | 25 |
| Measurement Point Illumination | 25 |
| Maintenance | 25 |
| Cleaning | 25 |
| Battery Replacement | 25 |
| Transmitter Built-in Fuses..... | 27 |
| Calibration Interval | 27 |
| Technical Data | 28 |

References marked on instrument or in Users Manual

 Warning of a potential danger, comply with Users Manual.

 Caution! Dangerous voltage. Danger of electrical shock.

 Reference. Please use utmost attention.

 Conformity symbol, the instrument complies with the valid directives. It complies with the EMV Directive 89/336/EEC are fulfilled, it also complies with the Low Voltage Directive (73/23/EEC).

 The Users Manual contains information and references, necessary for safe operation and maintenance of the instrument. Prior to using the instrument (commissioning / assembly) the user is kindly requested to thoroughly read the Users Manual and comply with it in all sections. Failure to read the Users Manual or to comply with the warnings and references contained herein can result in serious bodily injury or instrument damage.

General Information / Introduction /Scope of Supply

The FLUKE Cable Locator is a portable measurement instrument and can be used to detect or trace conductors.

Product Description

The FLUKE Cable Locator consists of a transmitter and a receiver. The signal generated by the transmitter is made of a modulated current, generating an electro-magnetic field around a conductor. This electro-magnetic field induces a voltage within the receiving coil. The induced voltage is amplified, decoded, and converted to the original signal by the receiver, and finally displayed on the screen. The connecting parameter for the transmitter during an application must be a closed current circuit.

The FLUKE Cable Locator is characterized by the following features:

- Finding conductors in walls, conductor interruptions, short-circuits in conductors
- Conductor tracing in the soil
- Detecting fuses and assigning current circuits
- Tracing sockets and distribution sockets having accidentally been covered by plastering
- Detecting interruptions and short-circuits in floor heating
- Tracing metallic water and heating piping
- All application areas (both, voltage-free and live) are performed without using any additional instruments
- Transmitter display indicates the transmission level, the transmission code, as well as the foreign voltage
- Receiver display indicates the reception level, the transmission code, as well as the mains voltage detection
- Automatic and manual sensitivity adjustment
- Acoustic reception signal may be switched off

- Auto-Power-Off function
- Backlight
- Additional lighting function when working under bad lighting conditions
- Additional transmitters are available to extend or distinguish several signals

Scope of supply

- 1 pc. FLUKE Cable Locator Transmitter
- 1 pc. FLUKE Cable Locator Receiver
- 4 pc. Test Leads
- 1 pc. Battery 9 V, IEC 6LR61
- 6 pc. Batteries 1,5V, IEC LR6
- 2 pc. Cocodile Clamps
- 2 pc. Test Probes
- 1 pc. Carrying Case
- 1 pc. Users Manual

Transport and Storage

Please keep the original packaging for later transport, e.g. for calibration. Any transport damage due to faulty packaging will be excluded from warranty claims. In order to avoid instrument damage, it is advised to remove batteries when not using the instrument over a certain time period. However, should the instrument be contaminated by leaking battery cells, you are kindly requested to return it to the factory for cleaning and inspection. Instruments must be stored in dry and closed areas. In the case of an instrument being transported in extreme temperatures, a recovery time of minimum 2 hours is required prior to instrument operation.











Safety Measures

The FLUKE Cable Locator has been constructed in accordance with the safety regulations for electronic test and measurement instruments and has left the factory in safe and perfect condition. To maintain this condition, the user must pay attention to the safety references contained in this Users Manual. This Users Manual contains information and warnings necessary for safe operation and maintenance of the instrument.

 The respective accident prevention regulations established by the associations for electrical systems and equipment must be strictly met at all times.

 In order to avoid electrical shock, the valid safety and VDE regulations regarding excessive contact voltages must receive utmost attention, when working with voltages exceeding 120V (60V) DC or 50V (25V)rms AC. The values in brackets are valid for limited ranges (as for example medicine and agriculture).

 Measurements in dangerous proximity of electrical installations are only to be executed when instructed by a responsible electrical specialist, and never alone.

-  Prior to usage, inspect instrument for external damage. Prior to any operation, ensure that connecting leads used and electronic load are in perfect condition.
-  If the operator's safety is no longer ensured, the instrument is to be put out of service and protected against use. The safety is no longer insured, if the instrument:
 - shows obvious damage
 - does not carry out the desired measurements
 - has been stored for too long under unfavourable conditions
 - has been subjected to mechanical stress during transport.
-  The Cable Locator may only be used on systems complying with the nominal voltages indicated in the technical data section.
-  However, we recommend to exclusively connect the transmitter from the phase towards the neutral conductor. If transmitter connection is realised from the phase towards the protective conductor, the functional safety of the protective conductor must be tested first, in compliance with DIN VDE 0100. The reason is that when connecting the transmitter from phase towards ground, all parts being connected to the earth may be live in the event of an error (if the earth resistance does not comply with the prescriptions).
-  If the RCD trips when connecting the sender (with reference to the protective earth contact PE), a fault current is already active within the installation which generates the RCD tripping when cumulated to the additionally fed current.
-  If the instrument is subjected to an extremely high electro-magnetic field, its functioning ability may be impaired.
-  Never try to disassemble battery cells ! The battery contains very strong base chemicals. Danger of causticization ! If the battery contents come in contact with skin or clothing, rinse immediately with water. If the battery contents come in contact with the eyes, immediately flush by using pure water and consult a doctor.
-  Never try to make contact between both battery cell poles, for example by using a wire connection. The resulting short-circuit current is very high and causes extreme heat. Danger of fire and explosion !
-  When replacing or changing the battery, make certain of correct polarity. Batteries with reversed polarity can lead to instrument destruction. Furthermore, they may explode or ignite.
-  Only use batteries as described in the technical data section
-  Avoid any heating up of the instrument by direct sunlight to ensure perfect functioning and long instrument life.

Appropriate Usage

⚠ The instrument may only be used under those conditions and for those purposes for which it was conceived. For this reason, in particular the safety references, the technical data including environmental conditions and the usage in dry environments must be followed.

⚠ When modifying or changing the instrument, the operational safety is no longer ensured.

Operation Elements and Connections

Transmitter

- 1) Terminal "+"
- 2) Terminal "ground"
- 3) LCD
- 4) Key Sensitivity Level
Repeated pressing allows selection between three transmission levels.
- 5) Key ON/OFF
To switch off the instrument press the button for approx. 2 seconds.
- 6) Battery case (backside)
- 6 a) Jumper for selectable Code (in battery case)
Standard setup is "Code F"

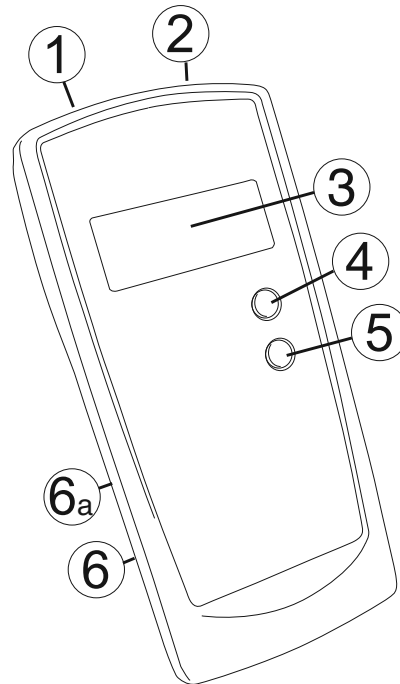

Transmitter – Display

- 3a) Transmitted Code
- 3b) Display for external voltage (i.e. 50 V)
- 3c) External voltage detection
The integrated foreign voltage detection feature is not appropriate to check (if the connection is live) ! To check that the system is live, use an appropriate voltage tester (e.g. FLUKE T100).
- 3d) Display for battery status
- 3e) Display transmitted level (I, II or III)

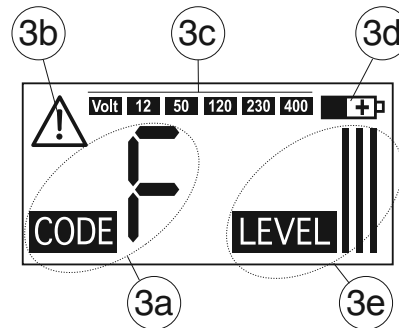

Receiver

- 7) Button to switch the acoustic display on or off
- 8) ON/OFF button to switch the instrument on or off / backlight. To switch off the instrument, press the button during 2 s, approximately. If no button is pressed during a certain period, the instrument automatically switches off after approximately 5 minutes. Briefly press the respective LCD backlight button to switch it on and off while the receiver is switched on.
- 9) LCD
- 10) Light
- 11) Sensor head
Slowly move the sensor head across the location to be searched. If the searching movement is too fast, the signal cannot be (recognized).
- 12) "UAC" button to select between cable locator mode and mains voltage detection mode
- 13) "- " button, to switch the light function mode on or off
This function is automatically switched off after approximately 60 seconds.
- 14) SEL button to switch on/of selective mode

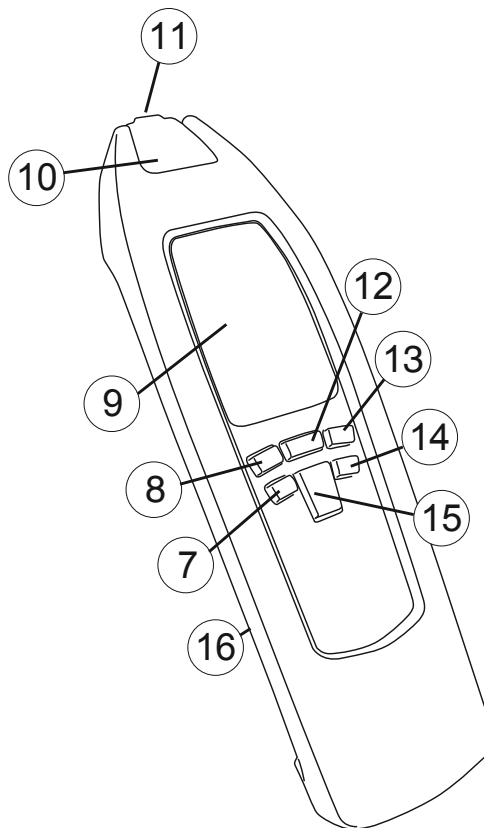

15) Toggle button for manual selection of the sensitivity

- ▼ upward selection
- ▲ downward selection

This button remains inactive when selecting the mains voltage detection mode.

Automatic Mode

(Standard setting after switch-on) If the automatic mode is selected the message "SIGNAL" is displayed. (9 d) and (9 j) indicate the signal intensity.

Manual Mode

Selection is made by means of ▼ "downward selection". If the manual mode is selected the messages "MAN" and "SENSE" are displayed. When further pressing "▼" the sensitivity may be reduced from "9" to "1".

👉 If the signal level available is high, it is recommended to select a low sensitivity level. .

“ When pressing "▲" the sensitivity may be increased from "1" to "9".

👉 If the signal level available is low, it is recommended to select a high sensitivity level.

If the sensitivity level "9" has been selected and "5" is pressed again, the instrument returns to automatic mode.

Selektive Modus

The change-over of modes is performed by pressing the "SEL" button (14). If the selective mode has been selected "MAN" (9 m) is displayed on the screen and "SEL" (9 j) appears in the numerical box. Reduction of sensitivity is made by pressing the "arrow down" button. The sensitivity display is performed by the "size" of the magnifying glass.

👉 If the signal level present is high, it is recommended to set a low sensitivity.

The sensitivity is increased when pressing the "▲" button.

👉 It is recommended to select a high sensitivity if the signal level present is low.

Once the maximum sensitivity is set and the "▲" button is pressed again, the instrument returns into automatic mode.

16) Battery case (on instrument rear)

Receiver – Display

- 9 a) Display to indicate that the acoustic display is switched off
- 9 b) Symbol to indicate the active LCD illumination
- 9 c) Information transmitted by the transmitter (transmission code and battery charge condition)
- 9 d) Display to indicate that the automatic mode is switched on
- 9 e) Bargraph display to indicate the signal intensity
- 9 f) Display for discharged battery
- 9 g) Manual mode: additional graphic display to indicate the selected sensitivity Display of the sensitivity within the selective mode.
Large magnifying glass => high sensitivity,
Small magnifying glass => low sensitivity
- 9 h) Display to indicate that the manual mode is active
- 9 i) Display for mains voltage
- 9 j) Automatic mode; digital display for signal intensity / manual mode, display of sensitivity/ SEL for selective mode.
- 9 k) Transmission level transmitted by the transmitter (LEVEL I, II, or III)
- 9 l) Display to indicate that the mains voltage detection is switched on
- 9 m) Display to indicate that the manual mode has been selected

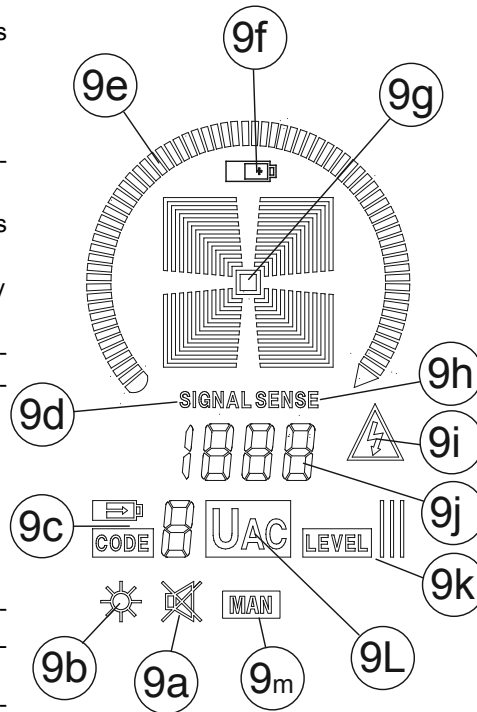

Cable Locator Mode

a) Automatic mode

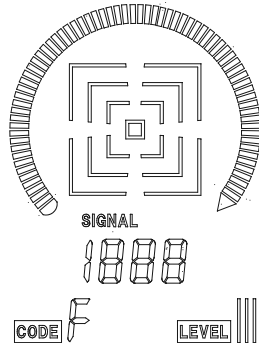

b) Manual mode

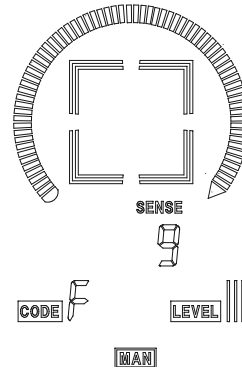

c) Selective Mode

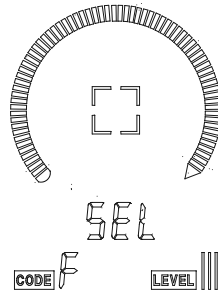

Mains Voltage Detection

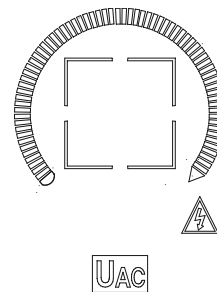

Carrying out measurement

 The transmitter should be connected between phase and neutral. First verify that the ground wire is in compliance with the VDE 100 for, when connecting the transmitter from phase to ground, all parts being connected to ground could be live during failures (in cases where the earth resistance does not comply with the regulations).

 If the RCD trips when connecting the sender (with reference to the protective earth contact PE), a fault current is already active within the installation which generates the RCD tripping when cumulated to the additionally fed current

Theoretical functional principle

The FLUKE Cable Locator consists of a transmitter and a receiver. The signal generated by the transmitter consists of a modulated current. Generating a magnetic field around a conductor, see figure 1. This electro-magnetic field surrounding the conductor induces a voltage within the receiver coils. For both modes, automatic mode and manual mode, the receiver works with three coils and does, not depend on a position. A selective and position-dependant search is performed in selective mode with only one active coil.

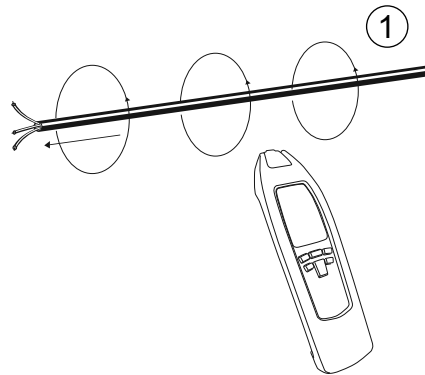

Locator in complete circuits

1st Possibility (one pole application)

Connect the transmitter to only one conductor. In this operational mode, the transmitter is supplied by the built-in battery. Due to the high-frequency signal generated by the transmitter, only one single conductor can be located and traced. The second conductor is the ground. This arrangement causes a high frequency current to flow through the conductor and to be transmitted to ground, similar to a radio and receiver. As from now on, we will call the above described operation one-pole application.

2nd Possibility (double-pole application)

Connect the transmitter to the mains. The transmitter is supplied by the mains. In this example, the modulated current flows through the phase into the transformer and back through neutral. There is a further possibility for voltage free systems by connecting the transmitter to two line terminals while short-circuiting the other line ends. Thus a complete circuit is created. Then, the transmitter is supplied by the built-in battery. From now on, we will call this operation double pole application.

👉 The FLUKE Cable Locator can only detect or locate lines, which are connected correctly in accordance with the physical principle described.

Important Application

For our example, we advise you to take a piece of a plastic-sheathed cable NYM 3 x 1,5 mm², for example. Provisionally install 5m of this cable along the wall with nail clips at eye level as surface mounting. Make sure that the wall is accessible from both sides. Create an artificial interruption at a distance of 1,5m before the line terminal. The line terminals must be open. Strip the interrupted lead at the lead at the start of the light plastic-sheathed cable and connect it via the measuring leads (supplied with the instrument) with terminal (1) of the transmitter.

Connect terminal (2) of the transmitter to a suitable ground. All other cable leads must also be connected to the transmitter and the same ground.

Switch in the transmitter via push button (5). Set the transmitter to "LEVEL I" via button (4). The transmitter function is indicated via the flashing of the signal lamp (3). During the manufacture process, the transmitter has been programmed to display the letter "F". Change the Code via Jumper (7).

Switch, on the receiver via pushbutton (8). All segments are indicated on the display (9) for a short period of time. This indicates that the receiver is functional and that the batteries are full. When switching on the receiver, the instrument is automatically set to "Automatic Mode". To change the sensitivity press the button 15. Now, the "Manual Mode" is activated. The sensitivity range comprises 9 levels. The respective sensitivity level, between 1 and 9, is changed and briefly displayed (9 + 9g) by pressing buttons (15). If a selective and position-dependent search has to be performed select the selective mode by pressing the button 14 SEL.

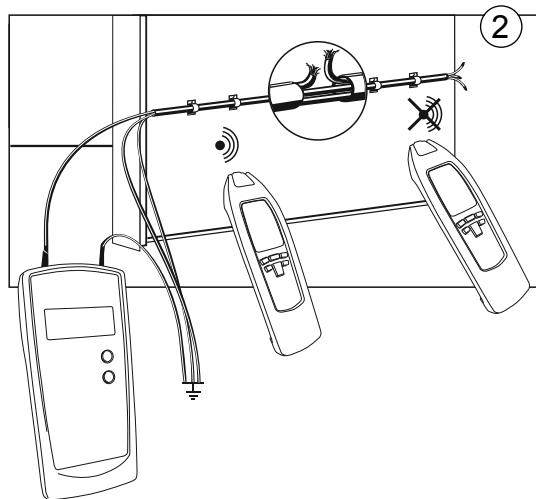

Now touch the light-plastic sheathed cable with your receiver just before the location of the interruption. With button (15) "SENSE" set the sensitivity level so as to just receive the "F" signal. The signal strength is indicated via the bargraph (9f). The display indicates the signal sent. Together with this optical indication, an acoustic signal is also emitted from the receiver. If the signal strength increases further, the bargraph (9f) is illuminated one after the other in accordance with the signal strength.

Now, using the lowest possible sensitivity level of the receiver, move along the cable and past the interruption. The signal "F" is not displayed any longer and the acoustic signal is not audible any more. Repeat the same experiment on the other side of the wall.

For this, set the transmitter to "Level III" using switch 4. Thus, the range increases by a factor 5.

To perform the test, it is good to mark the location of the artificial interruption on the opposite side of the wall. Select the sensitivity using button (15) to make sure that the signal "F" is only just receivable. Trace the signal in the wall with the receiver until it is no longer indicated. Localize the artificial interruption by systematically adjusting the sensitivity.

☞ The switching with button 4 from »LEVEL I« to »LEVEL III« the sensitivity of the Distance is increased up to factor 5.

In open circuits (one pole application)

Line interruptions in walls and floors. Finding and tracing of lines, sockets, junction box, switches, etc. for house installations. Finding bottlenecks, kinking and bucklings and obstructions in installation pipes by means of a metal coil.

The ground connector must be connected to a suitable earth. A typical example would be an earthed socket. The tracing depth amounts to 0...2 meters.

☞ The tracing depth depends on the medium and application

In complete circuits (double pole application)

When detecting short-circuits or during wire sorting, i.e. circuits with or without voltage. Voltage-free circuits are directly supplied by the instrument battery. In live circuits, the transmitter is supplied directly by the circuit connected. Switching from battery voltage to circuit voltage is carried out automatically. The transmitter is voltage-proof up to 400 V AC/DC.

Example for a complete circuit: Complete circuits are appropriate for: i.e. detecting sockets, switches, etc in live installations.

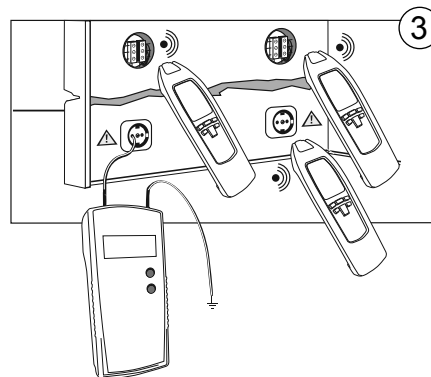

☞ The tracing depth amounts to 0...0,5 meters..The tracing depth depends of medium and application

⚠ When connecting in live circuits, safety regulations must be followed.

☞ The switching with button 4 from »LEVEL I« to »LEVEL III« the sensitivity of Distance is increased up to factor 5.

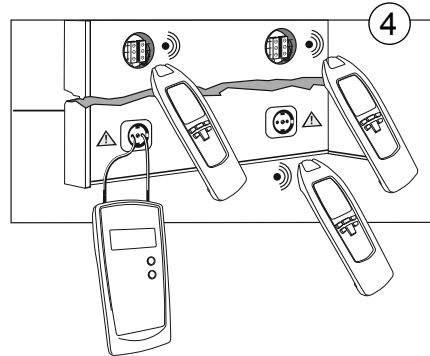

Locating and tracing of lines, sockets, switches and junctions in house installations circuits (one-pole application)

Requirements:

- The circuit must be dead.
- Neutral line and ground must be connected and fully operational.
- Connect transmitter to phase and neutral according to figure 7.
- Carry out this example as described in the application example.

With the one-pole indication, also lateral circuit branches can be traced.

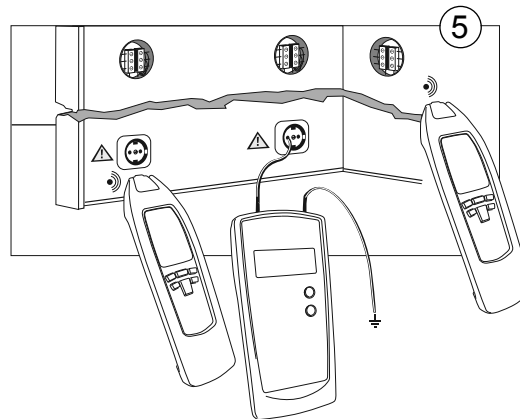

☞ If the supply cable fed with the signal via the transmitter is located, e.g. directly in parallel to other conductors (e.g. cable duct), or if these conductors are crossed, the signal is also input into the other conductors. The fuse must be removed during this example.

☞ The switching with button 4 from »LEVEL I« to »LEVEL III« the sensitivity of Distance is increased up to a factor of 5.

☞ Setup: manual mode, minimal sensitivity. Tracing depth max. 2 meters.

Locating of line interruptions (one-pole application)

Requirements:

- The circuit must be dead.
- All lines which are not required must be connected to the auxiliary ground in accordance with figure 8.
- Connect transmitter to one lead and to an neutral according to figure 8.
- Carry out this example as described in the application example.

Line interruption in the plastic-sheathed cable.

The ground connected to the transmitter should be earth from an earthed socket or a water pipe which is properly earthed.

When tracing line interruptions in multicore cables, not that all remaining leads in plastic-sheathed cable or conductor must be grounded in accordance with the regulations.

This is required to avoid crosscoupling of the fed signal (by a capacitive effect to the source terminals). The tracing depth for sheathed cable and conductors are different, as the individual leads in the sheathed cable are twisted around themselves.

The transition resistance of a line interruption must be higher than 100 kOHM. The verification of resistance can be carried out by any multimeter.

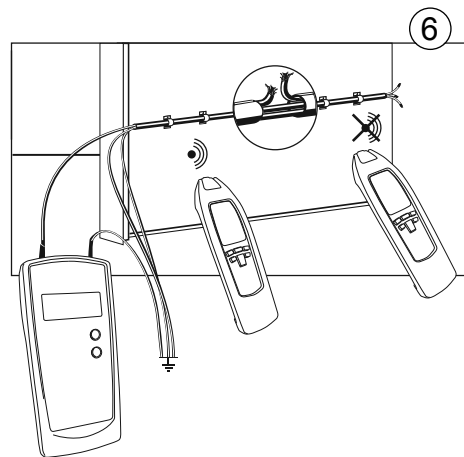

Systematically circle around the interruption the changing the sensitivity.

- ☞ The switching with button 4 from »LEVEL I« to »LEVEL III« the sensitivity of Distance is increased up to factor 5.
- ☞ Tracing depth max. 2 meters.
- ☞ Setup: manual mode, minimal sensitivity

Precise locating of line interruptions using two transmitters (one-pole application)

When locating a line interruption using one transmitter to feed from one conductor end, the location of interruptions may not be precisely located in case of bad conditions due to a field disturbance.

The drawbacks described above can easily be avoided when using two transmitters (one from each end) for line interruption detection. In this instance, each of the transmitters are set to a different line code (e.g. transmitter one to code "F, the other transmitter to code "C"). A second transmitter with a different line code is not included within the scope of supply and, therefore, has to be ordered separately. (Order number 2041 D with line code "C").

If the transmitters are connected in accordance with the figure 13, the receiver indicates "C" at the left side of the line interruption. If you continue further than the interruption, towards the right, the receiver displays "F". If you are directly above the interruption, no line code is displayed, due to the overlapping of both transmitter signals. The line interruption is located exactly in the middle between the displayed line codes "C" and "F"

Conditions:

- The current circuit must not be live.
- All lines not being used must be connected to the auxiliary ground as shown in the figure.
- Connect both transmitters as shown in the figure..
- Proceed as described in the application example.

The ground connected to the transmitter and to the wires not being used can be as follows is: an auxiliary ground, an orderly connected ground contact of a home office socket, or an orderly a grounded water pipe.

Please make sure during line interruption locating in multi-wire shielded conductors and cables, that all remaining wires are orderly grounded. This is required to avoid inductive disturbance (by capacity coupling).

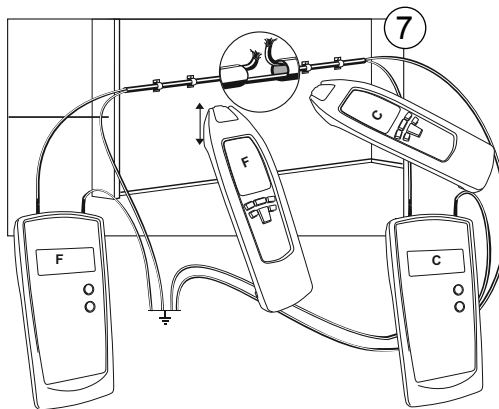

The locating depth for shielded conductors and cables varies, as the individual wires within the shield are twisted.

The transition resistance of a line interruption must be higher than 100 KOHM. The verification of resistance can be carried out by any multimeter.

- Systematically circle the interruption by changing the sensitivity.
- 👉 The switching with button 4 from »LEVEL I« to »LEVEL III« the sensitivity of Distance is increased up to factor 5.
- 👉 Setup: manual mode, minimal sensitivity. Tracing depth max. 2 meters.

Error detection for a electrical floor heating (one-pole application)

Please also note the connection conditions.

- ✎ If a shield mat or shield wiring is located above the heating wires, no ground connection may exist. If required, separate the shield from the ground connection.
- ✎ The switching with button 4 from »LEVEL I« to »LEVEL III« the sensitivity of Distance is increased up to a factor of 5.
- ✎ A second transmitter is required for this application.
- ✎ Setup: manual mode, minimal sensitivity. Tracing depth max. 2 meters.

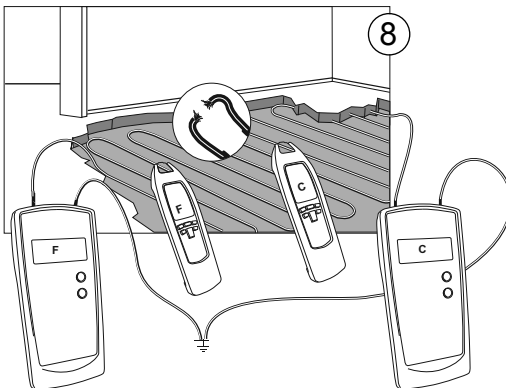

Locating of bottlenecks (obstructions) in installation pipes (single-pole application)

Requirements:

- Any circuits in the pipe must be dead and grounded.
- Connect transmitter to the metal coil and auxiliary ground according to figure 9.
- Carry out this example as described in the application example.

Systematically circle round the interruption the changing the sensitivity

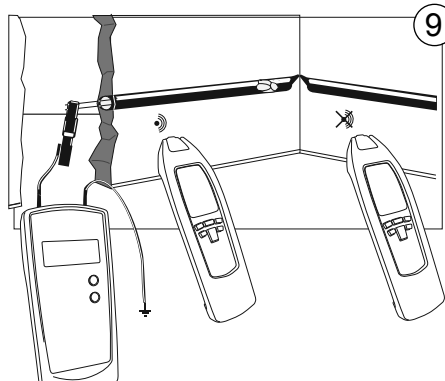

- ✎ If you have only coil actual of non conducting material (ex. fiber), we recommend you to slide a copper wire ex. 1,5 mm² up to the x-pipes.
- ✎ The switching with button 4 from »LEVEL I« to »LEVEL III« the sensitivity of Distance is increased up to a factor of 5.
- ✎ Setup: manual mode, minimal sensitivity. Tracing depth max. 2 meters.

Locating Fuses (dual-pole application)

 When connecting in live circuits, the safety directions must absolutely be respected.

Insert into the current circuit of a multifamily residential structure within a socket between L1 and N and switch the transmitter to "LEVEL I".

You may assign the signal in the secondary distribution and main distribution by transmitter pre-setting "LEVEL I". Thus, fuses and automatic devices can definitely be assigned to a certain current circuit.

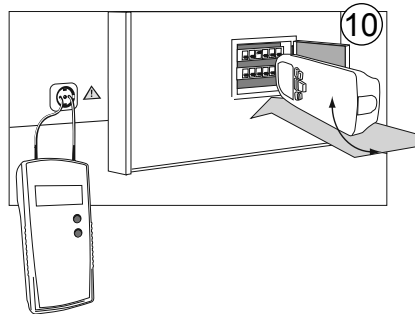

 The detection or assignment of the fuse strongly depends on the wiring realised within the distribution. To obtain a result as precise as possible, the cover should be removed and the supply line to the fuse should be traced.

- Set transmitter to LEVEL I

 The switching with button 4 from »LEVEL I« to »LEVEL III« the sensitivity of Distance is increased up to a factor of 5.

 Setup: selective mode, minimal sensitivity

 Safety cut-outs of different manufacturers have different installation positions for magnetic coils. If no evident signal can be found by the receiver in the position shown below it is advised to modify the position by 90° towards the left or the right.

Locating of short-circuits in conductors (double-pole application)

Requirements:

- Any existing circuits within the cable must be voltage-free.
- Connect transmitter in accordance with Figure 11.
- Carry out this example as described in the application example

Note that the tracing depth for sheathed cable and conductors are different due to the fact that the individual leads in the sheathed cable are twisted around themselves.

Usually, short-circuits can only be correctly detected when the short-circuit resistance is lower than 20 Ohm. The verification of the short-circuit resistance can be carried out with any multimeter.

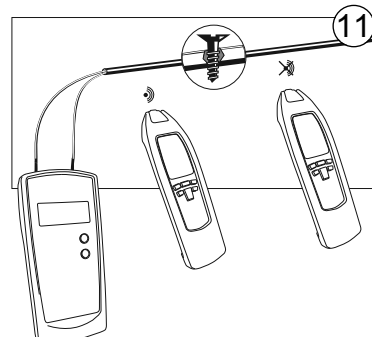

Should the short-circuit resistance amount to more than 20 Ohm, you can try the experiment to detect the error location by means of the line interruption method. You can try with sufficient energy to determine the error location (low ohmic connection) or to burn it in a way ensuring a line interruption.

- Systematically circle round the interruption by changing the sensitivity

👉 The switching with button 4 from »LEVEL I« to »LEVEL III« the sensitivity of Distance is increased up to a factor of 5.

👉 Setup: manual mode, minimal sensitivity. Tracing depth max. 0,5 meters.

Tracing installed water and heating pipes (one-pole application)

The following has to be respected:

👉 The line to be located must be separated from the equipotential bonding.

⚠ For safety reasons the electrical system must not be live!

Connect transmitter at foundation ground to the ground socket. The second transmitter socket has to be connected to the conductor to be located. Now the feed line can be traced.

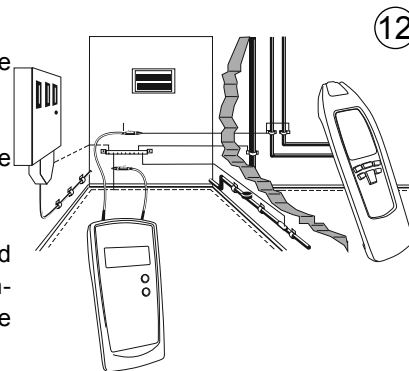

👉 The switching with button 4 from »LEVEL I« to »LEVEL III« the sensitivity of Distance is increased up to a factor of 5.

👉 Setup: manual mode, minimal sensitivity. Tracing depth max. 2 meters.

Detcting the direction of water and heating pipes already installed (one-pole application)

Requirements:

- The respective water and heating pipes must be suitably grounded.
- Connect the transmitter according figure 13.
- Carry out this example as described in the application example.

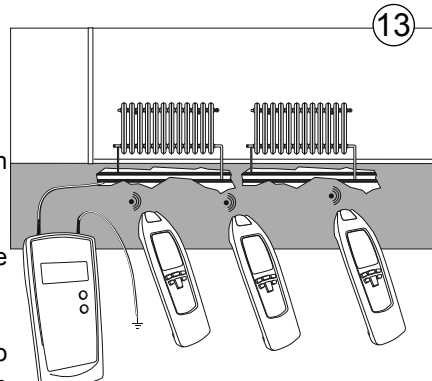

The earth of a properly earthed socket is a suitable ground.

👉 The switching with button 4 from »LEVEL I« to »LEVEL III« the sensitivity of Distance is increased up to a factor of 5.

👉 Setup: manual mode, minimal sensitivity. Tracing depth max. 2,5 meters.

Locating a complete house wiring (one-pole application)

Practical application example

In order to determine all electrical lines of a house within one working process, proceed as follevel is:

- Remove the bridge in the main distribution between "PE" and "N".

⚠ For safety reasons, the system must not be live!

- Connect the transmitter to the system compliance with the figure 14. Now, the neutral conductor, being present within the total system, may be followed.

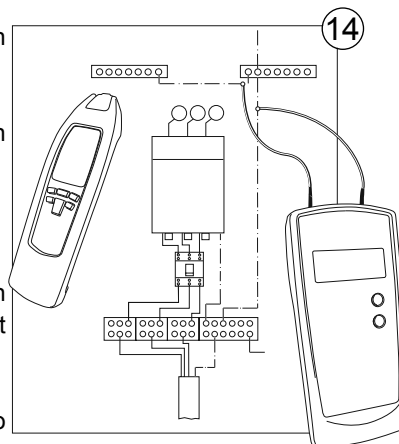

👉 The switching with button 4 from »LEVEL I« to »LEVEL III« the sensitivity of Distance is increased up to a factor of 5.

👉 Setup: manual mode, minimal sensitivity. Tracing depth max. 2 meters.

Following lines with higher location depth (dual-pole application)

If the dual-pole application is carried out on multi-wire cables (e.g. NYM 3x1.5mm²), the location depth is widely limited. The reason is that the go-and-return lines are installed very closely. Thus, a strong distortion of the magnetic field occurs. The electro-magnetic field may not develop at the bottleneck. This limitation can easily be eliminated when using a separate conductor to simulate the return line. This separate conductor allows for a larger spreading of the electro-magnetic field. Any conductor or cable reel can be used as separate return conductor.

When tracing the conductors, special care has to be taken that the distance between go-and-return-line is larger than the location depth. In practical applications, this amounts to approx. 2.0 meters..

For this application, humid walls, plaster, etc. have only an insignificant influence on the location depth

- The current circuit must not be live.
- Connect the transmitter in compliance with the figure 15.
- The distance between go-and-return line must be minimum 2.0 meters to 2.5 meters or more.
- Proceed as described in the application example.

👉 The switching with button 4 from »LEVEL I« to »LEVEL III« the sensitivity of Distance is increased up to a factor of 5.

👉 Setup: manual mode, minimal sensitivity. Tracing depth max. 2.5 meters.

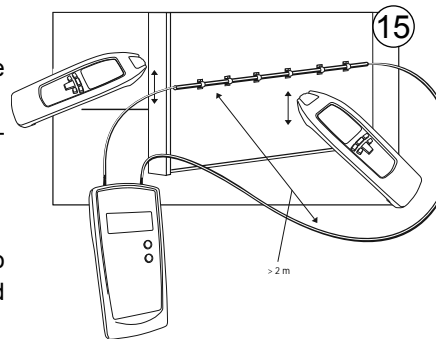

Tracing Conductors Within the soil (single-pole application)

The connection is realised in compliance with Figure 16.

⚠️ Ensure that the current circuit is not live.

👉 Make sure that the distance between the connection to the ground and the conductor to be detected is high. If the distance is too close, no definite assignment of the signal received can be made to one conductor.

👉 The tracing depth amounts to maximum 2 meters. Furthermore, the tracing depth strongly depends on the soil characteristics.

- Set the receiver to automatic mode.
- Now, search or trace the conductor by means of the signal intensity (9e + 9j) displayed. When circling the receiver slowly across the conductor to be searched, the display values change considerably. The display of the maximum signal intensity is performed directly via the conductor.

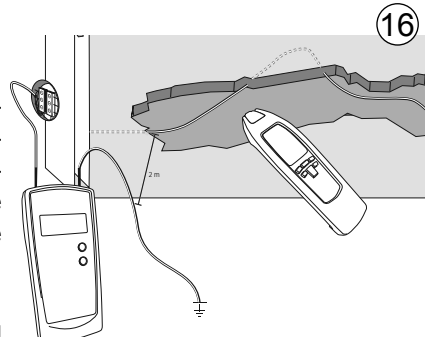

- ☞ The signal intensity level decreases with increasing distance of the fed-in signal (transmitter).

The reach will be improved when seeking the tension

If the transmitter is attached at the phase and the neutral coil directly gets lost the signal in the line going parallelly to and back (see figure).

- ☞ The range can partly lead to signal fall off when twisting the conductors among each other. The reach is max. 0,5 meters.

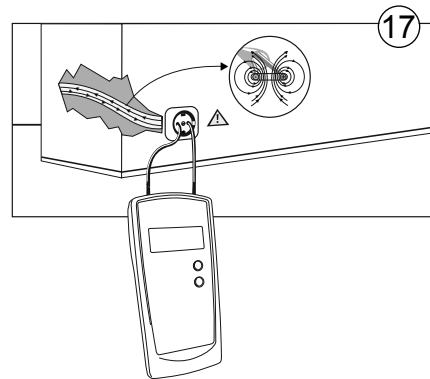

To turn the effect pointed in the upper figure off, the connection should be carried out like the figure 18. The backline is produced about a separate cable. The distance in in voltage-circuits will be up to 2,5 meters. Back coils at higher distance i.e. Cabletrace (see figure)

- ☞ Respect sufficient distance to the conductor to be located in order to allow an unambiguous assignment between the signals received and the conductor.

- ☞ Comply with the safety references when performing connections on live circuits!

- ☞ The switching with button 4 from »LEVEL I« to »LEVEL III« the sensitivity of Distance is increased up to a factor of 5.

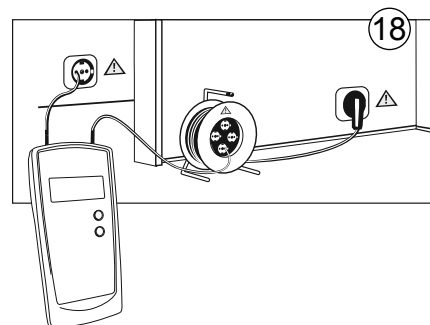

Sorting or determination of conductors already installed (double-pole application)

Requirements:

- Any existing circuits within the cable must be voltage-free.
- The lead terminals must be twisted and electrically connected between each other
- You need several transmitters, with different transmitter signals (A to F or 0 to 9).
- Connect the transmitter according to figure 19.
- Carry out this example as described in the application example.

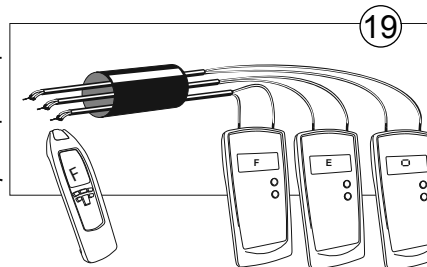

For this application example, please pay attention that the stripped lead terminals are twisted with each other. The electrical connection between the stripped lead terminals must be good.

In case only one transmitter is available, the sorting of the sheathed cables can be carried out by sequentially reconnection the transmitter.

- ✎ The switching with button 4 from »LEVEL I« to »LEVEL III« the sensitivity of Distance is increased up to a factor of 5.

Mains Voltage Detection Locating Line Interruptions

The test is performed in compliance with Figure 20.

- ✎ No transmitter is required for this application.

- Set the receiver to the "Mains voltage detection" mode.

The bargraph display indicating the signal intensity (9e) and the signal sound frequency depends on the level of the voltage to be tested and the distance to the live conductor. The higher the frequency, the higher the voltage, or the lower the distance to the conductor.

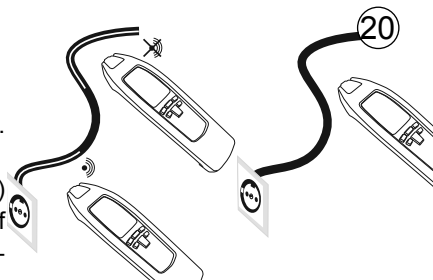

- ⚠ Different signal intensities do not allow any assumptions regarding type and intensity of the voltage present. A definite statement regarding the voltage present may only be made when using a measurement instrument equipped with a display.

When testing mains connection cables for interruptions, make sure that both conductors are connected once to the phase (turn mains plug by 180°).

Setting the Codes

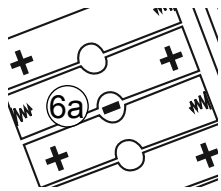

Make sure that the instrument is switched off before setting the codes.

- Remove the batteries from the transmitter in compliance with section 8.2.
- Remove the jumper within the battery case (6 a).
- Place the batteries respecting correct polarity.
- Switch on the transmitter pressing button 5.
- Select the required code using button 4

☞ Code selection can be made as follows (R, F, E, H, O, O, C).

- Switch off the transmitter using button 5, remove the batteries, and reset the jumper
- Replace the transmitter batteries and the battery case.
- The instrument is now ready for use and the code is newly set.

Measurement Point Illumination

Press button 13 for measurement point illumination (10). The instrument switches off automatically after approximately 60 seconds or it can be switched off manually when pressing the button 13 again.

Maintenance

When using the instrument in compliance with the Users Manual, no special maintenance is required. For any queries regarding the instrument, please always quote product designation and serial number, both marked on the type shield label on instrument rear. If functional errors occur after expiration of warranty, our after sales service will repair your instrument without delay.

Cleaning

If the instrument is dirty after daily usage, clean it by using a wet cloth and a mild household detergent.

⚠ Prior to cleaning, ensure that instrument is switched off and disconnected from external voltage supply and any other instruments connected (such as UUT, control instruments, etc.).

Never use acid detergents or dissolvants for cleaning.

Battery Replacement

The batteries have to be changed, when the symbols (3 d-Transmitter/ 9 c-Receiver) are displayed.

⚠ Prior to storage battery replacement, disconnect the instrument from any connected test leads.

☞ Please refer to the description on the bottom of the battery case for correct layout of batteries.

⚠ Reverse polarity of batteries may destroy the instrument. Furthermore, they may explode or ignite

⚠ Only use batteries as described in the technical data section! (6 x 1,5 V type IEC LR6, Mignon).

⚠ Never try to disassemble battery cells ! The battery contains very strong base chemicals. Danger of causticization ! If the battery contents come in contact with skin or clothing, rinse immediately with water. If the battery contents come in contact with the eyes, immediately flush by using pure water and consult a doctor.

⚠ Never try to make contact between both battery cell poles, for example by using a wire connection. The resulting short-circuit current is very high and causes extreme heat. Danger of fire and explosion !

- Disconnect the instrument from the mains and switch them off.
- Open and remove battery case cover on instrument rear.
- Remove used batteries
- Insert new batteries by respecting the polarity (see figure).
- Close battery case
- The instrument is now operational.

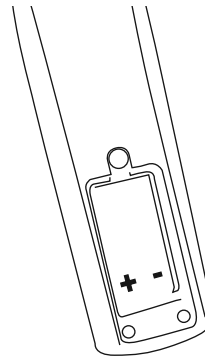
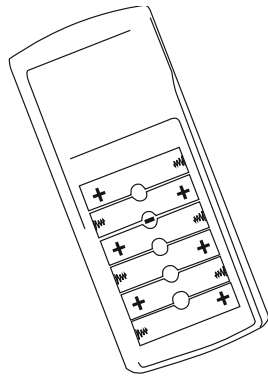

⚠ Please consider your environment when you dispose of your one-way batteries or accumulators. They belong in a trash for hazardous waste. In most cases, the batteries can be returned to their point of sale. Please, comply with the respective valid regulation regarding the return, recycling and disposal of used batteries and accumulators.

 If an instrument is not used over an extended time period, the batteries must be removed. Should the instrument be contaminated by leaking battery cells, the instrument has to be returned for cleaning and inspection to the factory.

 If an instrument is not used over an extended time period, the accumulators or batteries must be removed. Should the instrument be contaminated by leaking battery cells, the instrument has to be returned for cleaning and inspection to the factory.

Transmitter Built-in Fuses

The built-in fuses protect the instrument against overload or faulty manipulation.

 The built-in fuse may only be replaced by our factory service department.

Detecting that a fuse has tripped: The reason for the output signal generated by the transmitter being only weak could be that the fuse has tripped. To verify whether the fuse has tripped, please proceed as follows:

- Disconnect the transmitter from all connected measurement circuits.
- Switch on the transmitter.
- Set transmission level I.
- Perform a single-pole connection of one test lead to socket 1.
- Switch on the receiver. Search for the signal at the cable and place the sensor head on the cable.
- Insert the open cable end into connection socket 2.
- If the fuse is not defective, the displayed value on the receiver screen doubles.

Calibration Interval

We suggest a calibration interval of one year. If the instrument is used very often or if it is used under rough conditions we recommend shorter intervals. If the instrument is used few times only the calibration interval can be extended on to 3 years.

Technical Data

Transmitter:

| | |
|-----------------------------------|---|
| Output signal | 125 kHz |
| External voltage detection | |
| Voltage Range | 12...400 V |
| Frequency Range | 0...60 Hz |
| Display | LCD with display of functions |
| External Voltage Detection | max. 400 V AC/DC |
| Over Voltage Category | CAT III/300 V |
| Pollution Degree | 2 |
| Power Supply | 6 x 1,5 V, IEC LR6 |
| Power Consumption | max. 40 mA |
| Fuse | F 0.5 A 500V, 6.3 x 32 mm |
| Temperature | |
| Range (Work) | 0...40°C, max 80% rel. humidity (not condens.) |
| Temperature Range (Storage) | -20...+60°C, max 80% rel. humidity (not condens.) |
| Height above MSL | up to 2000 meters |
| Dimensions | 190 x 85 x 50 mm |
| Weight | approx. 260 g (without battery) |
| | approx. 400 g (with battery) |

Receiver:

| | |
|-----------------------------------|---|
| Tracing depth | The tracing depth depends of medium and application |
| Cable Locator Mode | approx. 0...2 meters (single-pole application) |
| | approx. 0...0.5 meters (double-pole application) |
| Voltage detection | approx. 0...0.4 meters |
| Display | LCD with functions- and bargraph |
| Power Supply | 1 x 9 V, IEC 6LR61 |
| Power Consumption | approx. 17 mA (without backlight or lamp) |
| | approx. 50 mA (with backlight) |
| | max. 70 mA (Backlight and lamp) |
| Temperature Range (Work) | 0...40°C, max 80% rel. humidity (not condens.) |
| Temperature Range (Storage) | -20...+60°C, max 80% rel. humidity (not condens.) |
| Height above MSL | up to 2000 meters. |
| Dimensions | 250 x 65 x 45 mm |
| Weight | approx. 220 g (without battery) |
| | approx. 270 g (with battery) |